



CITEL

SURGE PROTECTORS

FOR

Wind Turbines

[www.citel.fr](http://www.citel.fr)

# Professional surge protection for wind turbines



## • Necessity of Surge Protection

### Wind turbines are at high risk of lightning strikes.

Wind turbines are usually located in open areas with excellent wind resources. For example, onshore wind power generation is located in protruding terrain such as ridges, while offshore wind power generation is usually located in areas with high ground flash density near coastlines. At the same time, blades of the wind turbines can induce and trigger upward leaders and actively connect with downward leaders in electrostatic fields of thunderstorms, which greatly increases the probability of lightning striking the blades. For this reason, the estimated annual average number of lightning strikes on wind turbines is much higher here than in other areas.

### High maintenance costs.

Lightning strikes on a wind turbine may cause blade ablation, a failure of an electrical and control system, and other phenomena. There are many such cases. The yield loss caused by wind turbine maintenance and downtime is very large. For an offshore wind turbine, the maintenance costs are particularly high, and the maintenance period is long. As a result, a big indirect loss is brought by the halt.

### The threat caused by a lightning electromagnetic pulse is huge.

Compared with direct lightning strikes, the indirect effect of lightning strikes, namely a lightning electromagnetic pulse (LEMP), is more risky to the electrical and control system of the wind turbine. The main reasons are as follows:

- the probability of lightning strikes on wind turbine blades is high, and the radiated electromagnetic field can cover the entire wind power plant;
- the operating systems of sensitive equipment, such as a main control and a pitch control system, have low immunity;
- the components and parts of the equipment have low capacity to endure LEMP and are prone to breakdown or insulation damage;
- the cable length of the interconnection between the wind turbines and the distance to the grid connection point is long in open areas. The induced overvoltage can be very significant.

### Reasonable installation of SPD is the most effective method.

LEMP is currently the main threat for breakdowns and failures of the electrical and electronic system. At present, the most cost-effective and reasonable main measures are taken: installing a surge protective device (SPD), which discharges the energy matches with the endurance capability of the protected equipment and the immunity of the system, at the boundaries of the lightning protection zones or at the front end of the protected equipment.

## • Standardization Requirements

The basic protection method of wind power generation needs to meet the requirements of the basic protection standards of the lightning protection industry: the international standard IEC 62305-1 to 4 and the national standard

The general and special requirements for wind power industry applications need to meet the requirements of standards IEC 61400-24, which provide requirements for protection of blades, other structural components, and the effects of direct and indirect lightning strike on the electrical and control system while putting forward a request for typical environmental effect factors that the SPD should be able to bear.

With regard to the performance and model selection requirements of the surge protection device, testing and model selection are required in accordance with SPD-related standards IEC 61643.

## • Division of Lightning Protection Levels

In accordance with IEC 62305, four lightning protection levels are formed, LPL I to IV. For each LPL, the maximum and minimum values of the lightning current parameters that can be protected are specified (see the table below). In accordance with the requirements of the wind power lightning protection standards IEC 61400-24, it is the most reasonable that the wind turbine set and the component system should be divided according to the highest lightning protection level LPLI (except for special requirements).

First positive return strike lightning current			Lightning Protection Level (LPL)			
Current parameters	Symbol	Unit	1	2	3	4
Peak current	I	kA	200	150	100	
Impulse charge	Q <sub>SHORT</sub>	C	100	75	50	
Specific energy	W/R	MJ/Ω	10	5.6	2.5	
Time parameters	T1/T2	μs/μs	10/350			

# LIGHTNING PROTECTION ZONES (LPZ)

## • Sectioning of a typical wind turbine into LPZ

Defining reasonable lightning protection zones of the wind turbine is a prerequisite for effective surge protection. In general, protection measures, such as a lightning protection system (LPS), the shielding of the wire, and the installation of SPDs, are used to determine the lightning protection zones (LPZ). For details, see Chapter 8.3 of IEC 62305-1.

The following is a schematic diagram \* of division of the typical wind turbine into lightning protection zones.

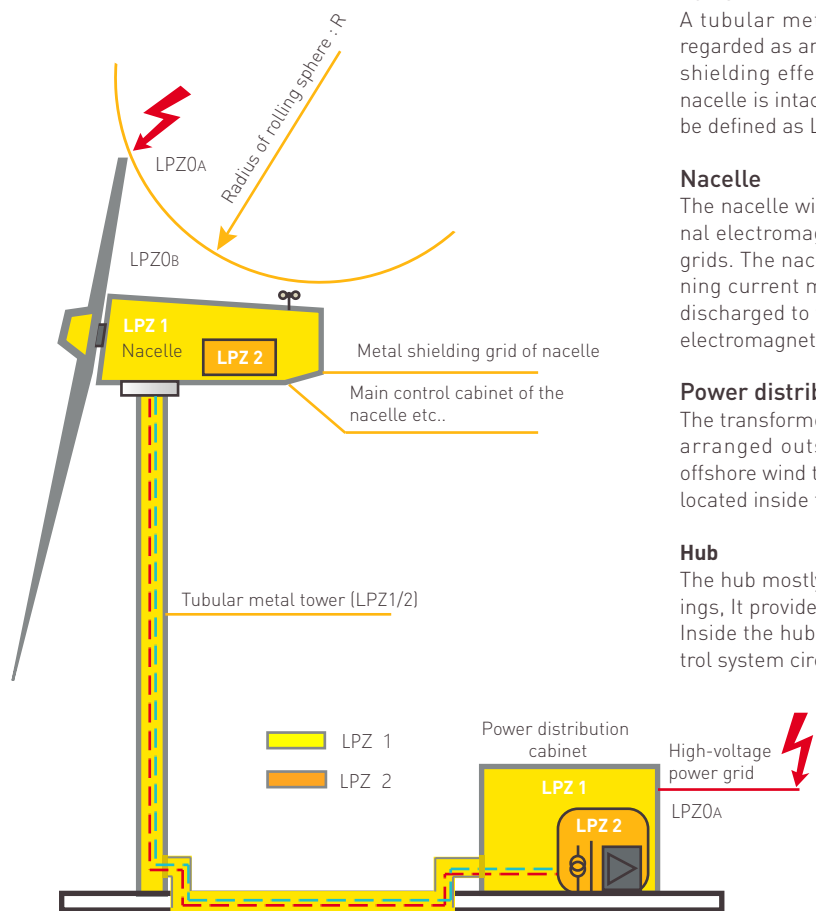

\*Note: The locations of power distribution room/cabinets of wind turbines of different models vary. For example, the offshore wind power distribution cabinet is normally located inside the tower.

### Tower

A tubular metal tower, which is used for a large wind turbine, can be regarded as an almost perfect Faraday cage, owing to its electromagnetic shielding effect. If the electrical connection between the tower and the nacelle is intact and safety grounding is done, the area inside the tower can be defined as LPZ1 or even LPZ2.

### Nacelle

The nacelle with glass fiber metal grids has a shielding effect on an external electromagnetic field. The shielding effect is related to the size of the grids. The nacelle is generally defined as an LPZ1 zone. A portion of lightning current may exist in the nacelle to flow through bearings so as to be discharged to the ground via an electric brush, so there may be a radiated electromagnetic field that cannot be shielded by the metal grids.

### Power distribution room (box)

The transformer and the grid connection of onshore wind turbines is mostly arranged outside the tower and can be defined as an LPZ1 zone. For offshore wind turbines, the transformer and the grid connection is normally located inside the tower and can be defined as an LPZ2/3 zone.

### Hub

The hub mostly consists of a hollow cast iron structure with multiple openings. It provides a magnetic shielding and should be defined as LPZ 1 zone. Inside the hub the pitch control system is located as well as different control system circuits leading to the nacelle.

Defining reasonable lightning protection zones is the prerequisite for effective surge protection

## • LPZ division and surge protection

The typical LPZ method is used for wind turbines to evaluate and determine the degree of influence of lightning strikes. Components like blades, machines, electrical and control systems can be build to endure this stress.

The test type, discharge capability and installation location of the SPD should be determined according to the influence characteristics of the electrical system at the boundaries of different protection zones. Examples of surge protection measures (SPM) of the electrical system at the boundaries of different protection zones are as follows:

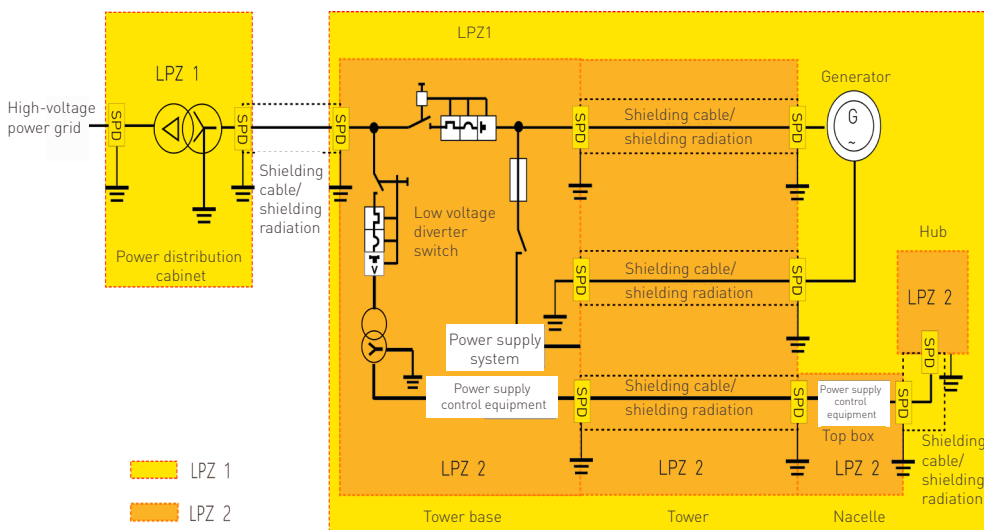

# TYPICAL REQUIREMENTS FOR WIND TURBINES

In general, one of three different types of wind turbine sets is used in a wind energy generation system. A doubly-fed induction generator (DFIG), a direct drive generator (PMSG) and a medium-speed generator (a semi-direct drive generator).

## • Transient Overvoltage Characteristics

Two main types of transient overvoltage may occur during the operation of the wind turbine:

### Transient overvoltage of DFIG converter switching circuit

As a switching device, IGBT is widely applied to converters. When the IGBT modulates and outputs PWM waves to a rotor, the voltage will produce recurring high peaks and transients (harmonics) of the gradient ascending time (du/dt). This harmonic interference will affect the insulation of the rotor generator and the normal operation of the SPD.

### Long cables transmit transient voltage

A converter at the bottom of the tower outputs pulse width modulation waves (PWM), and the distance of transmission of the pulse width modulation waves to a cable of the generator of the nacelle is long. Since long cables have distributed inductance and coupling capacitance, high-frequency overvoltage damped oscillation (harmonics) will be generated.

The possible overvoltage characteristics of the wind turbine are as the standards (the table below). If the endurance capacity of the SPD does not meet the requirements of on-site working conditions, its life expectancy will be greatly reduced.

Typical voltage characteristics of rotor side of DFIG	
maximum continuous operating voltage of the system (L-L)	750V r.m.s.(±10%), 0~200Hz
transient overvoltage repeatedly superimposed over the operating voltage L-PE	1.7 kV
transient overvoltage repeatedly superimposed over the operating voltage L-L	2.95 kV
The ascending gradient of repeatedly superimposed overvoltage waveforms	1.4 kV/μs
The switching frequency of the converter	2000 Hz

## • The requirements on HVRT for wind turbines

The high voltage ride-through characteristics given by the relevant standards and shown in the figure below will appear when the electrical system of the wind turbine operates. This type of temporary overvoltage (TOV) will appear in DFIG&PMSG, which may pose a threat to the safe operation of semiconductor equipment including a converter and the like.

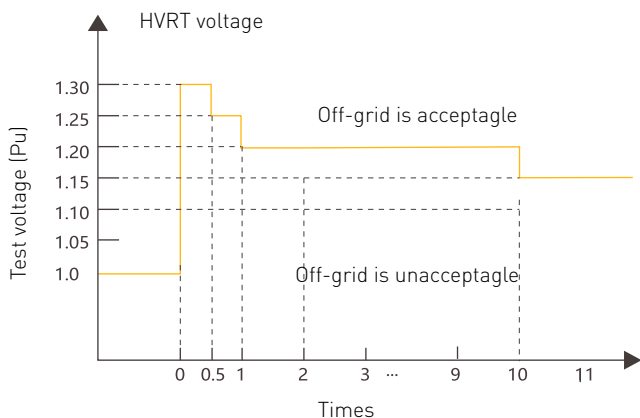

CITEL developed an SPD comprehensively considering multiple operating characteristics of the wind power system => reliable and safety protection



## CITEL SPD conform to HVRT requirements for wind

N°	Operating voltage	HVRT requirements	CITEL model	SPD parameter	Conclusion
1	400/690Vac	400*1.1=440Vac continuous	DAC50S-30-760	U <sub>c</sub> =760Vac continuous	Satisfied
2		400*1.3=520Vac 500ms		U <sub>i</sub> =1000Vac 5s withstand	Satisfied
3		400*1.1=440Vac continuous	DAC50S-31-760 -2600DC	U <sub>c</sub> =800Vac continuous	Satisfied
4		400*1.3=520Vac 500ms		U <sub>i</sub> =2200Vac 5s withstand	Satisfied
5	230/400Vac	230*1.1=253Vac continuous	DAC50S-31-320	U <sub>c</sub> =320Vac continuous	Satisfied
6		230*1.3=299Vac 500ms		U <sub>i</sub> =335Vac 5s withstand	Satisfied

## • Requirements of the system for the immunity

For the incoming line (there is a portion of intrusive lightning current on the line) connected to the LPZ0A or LPZ0B, AC ports and DC ports of electronic equipment such as the main control system, should be subjected to an immunity test in accordance with the standards IEC 61400-4-5 and IEC 60664-1, the communication port should be tested by reference to ITU-TK.21, K.20 and IEC 61400-4-5.

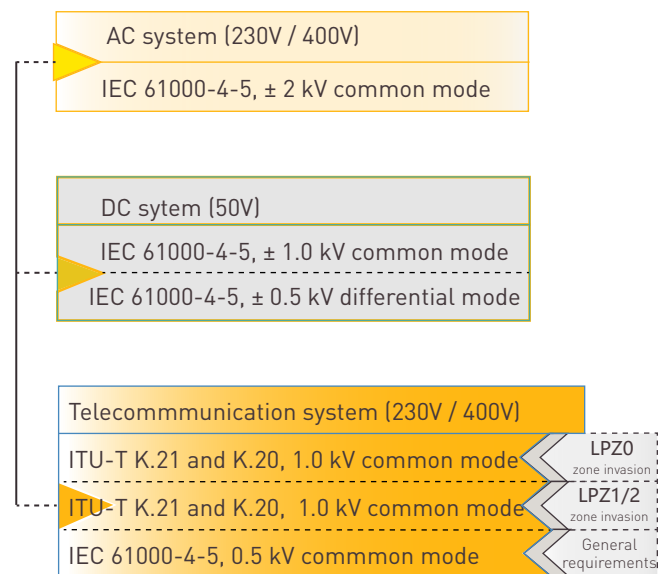

## • Environmental Requirements for SPDs Installed in Wind Turbines



Temperature and humidity



Vibration



Salt spray

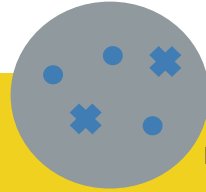

Mildew

**CITEL SPD** temperature range:  
-40 °C to 85 °C (limit)  
**CITEL SPD** humidity range:  
5% to 95 % (limit)

**CITEL SPD** vibration meets:  
IEC 61400-24 requirements

**CITEL SPD** salt spray meets the requirements:  
adopting the closed discharge technology  
being suitable for the marine salt spray environment

**CITEL SPD** meets the anti-mildew requirements:  
anti-mildew and antibacterial shell materials  
DAC&DDC performance is better

## • Standard Requirements for Application of SPD in Offshore Wind Power

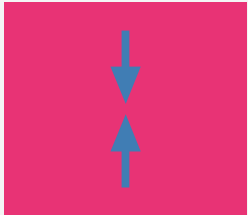

Open gap  
limited use

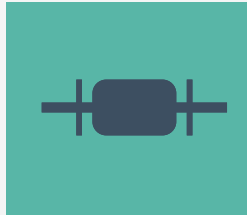

**CITEL** high energy  
Gas Discharge Tube:  
GSG

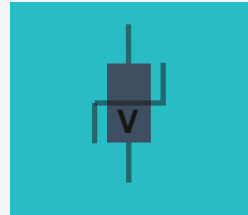

Varistor

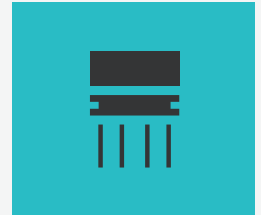

Transient suppression  
diode

## SPD KEY PARAMETERS' REQUIREMENTS

### • Voltage Protection level - Up

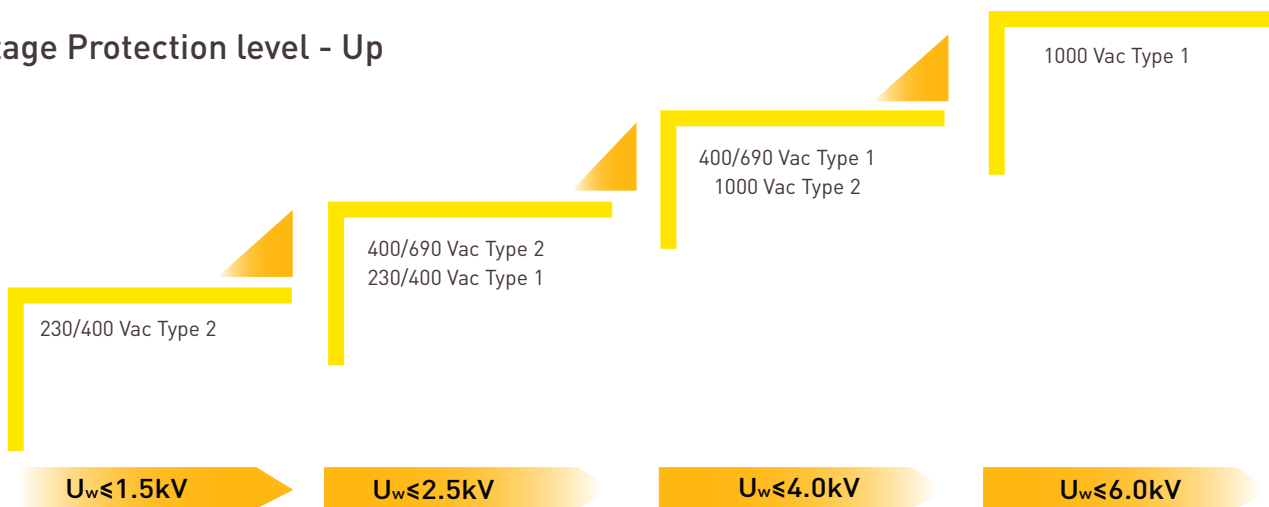

The voltage protection level  $U_p$  of the SPD used by the wind turbine should consider the rated impulse withstand voltage  $U_w$  of the protected equipment (as shown in the table above). If necessary, requirements for the immunity level of an SPD installation system of the wind turbine should be considered at the same time.

## • Maximum safe continuous operating voltage - Uc

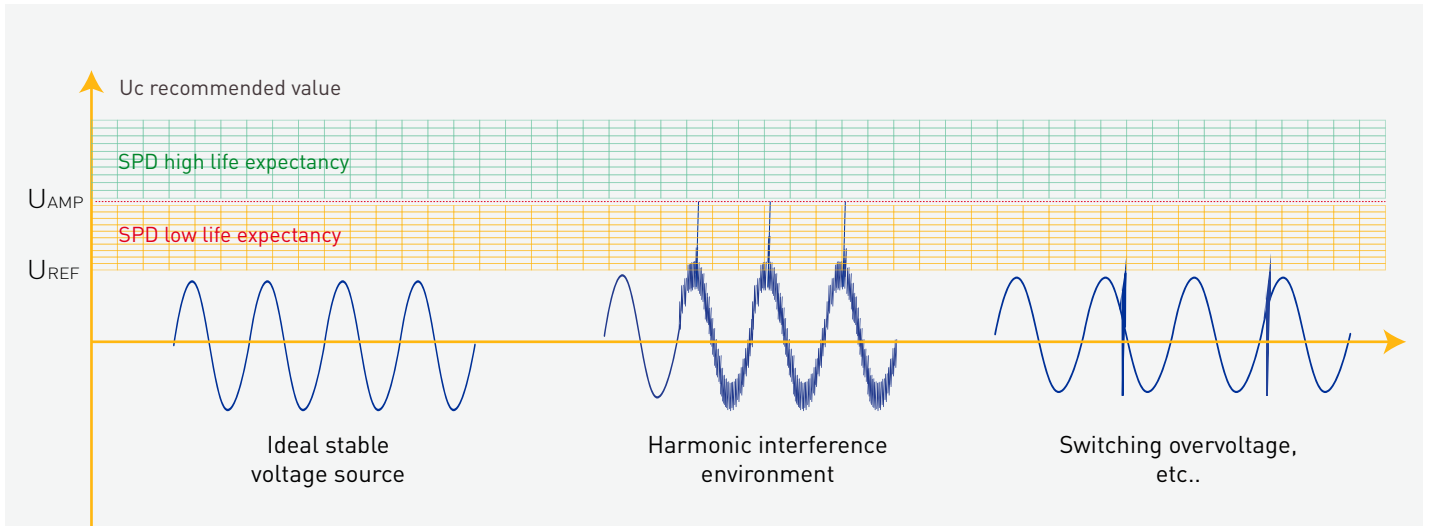

When considering the value of  $U_c$  to choose the SPD, the basic requirements such as the operating voltage of a power source at the SPD installation location and the power distribution system should be considered, and then the system reference voltage ( $U_{REF}$ ) should be determined for model selection. At the same time, wind power applications should especially consider whether there is harmonic interference at the installation location. If yes, the system operating voltage amplitude ( $U_{AMP}$ ) and the frequency of occurrence need to be considered, some areas with high switching frequency will have switching overvoltage, and some systems need to consider temporary overvoltage resulting from fault voltage (e.g. loss of neutral) and other situations.

As shown in the figure above, an SPD with a selected  $U_c$  in the yellow area may operate frequently in the range of the harmonic disturbances. This continuous operations will reduce the lifetime of the SPD. Therefore, it is recommended for wind power applications to select an SPD with an  $U_c$  value in the green area, in order to have the service life prolonged.

## • Discharge current requirements - $I_n$ & $I_{imp}$

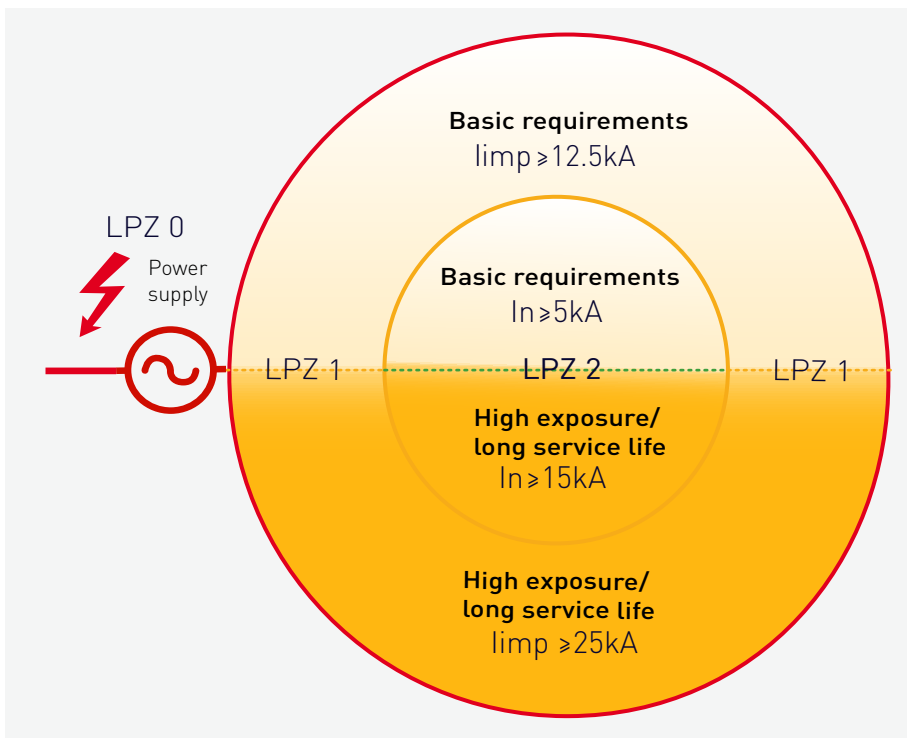

Wind power SPD  
designed by CITELE  
**Better protection,  
longer service life**



For a wind turbine, a matched discharge type SPD (Type 1+2+3) should be selected, according to the zone where the protection device is located, and meanwhile the exposure of the SPD installation position, the expected service life requirements, the power distribution system, the expected shunt size and other characteristics should be considered



# DOUBLE-FED INDUCTION GENERATOR (DFIG) SURGE PROTECTION SOLUTIONS

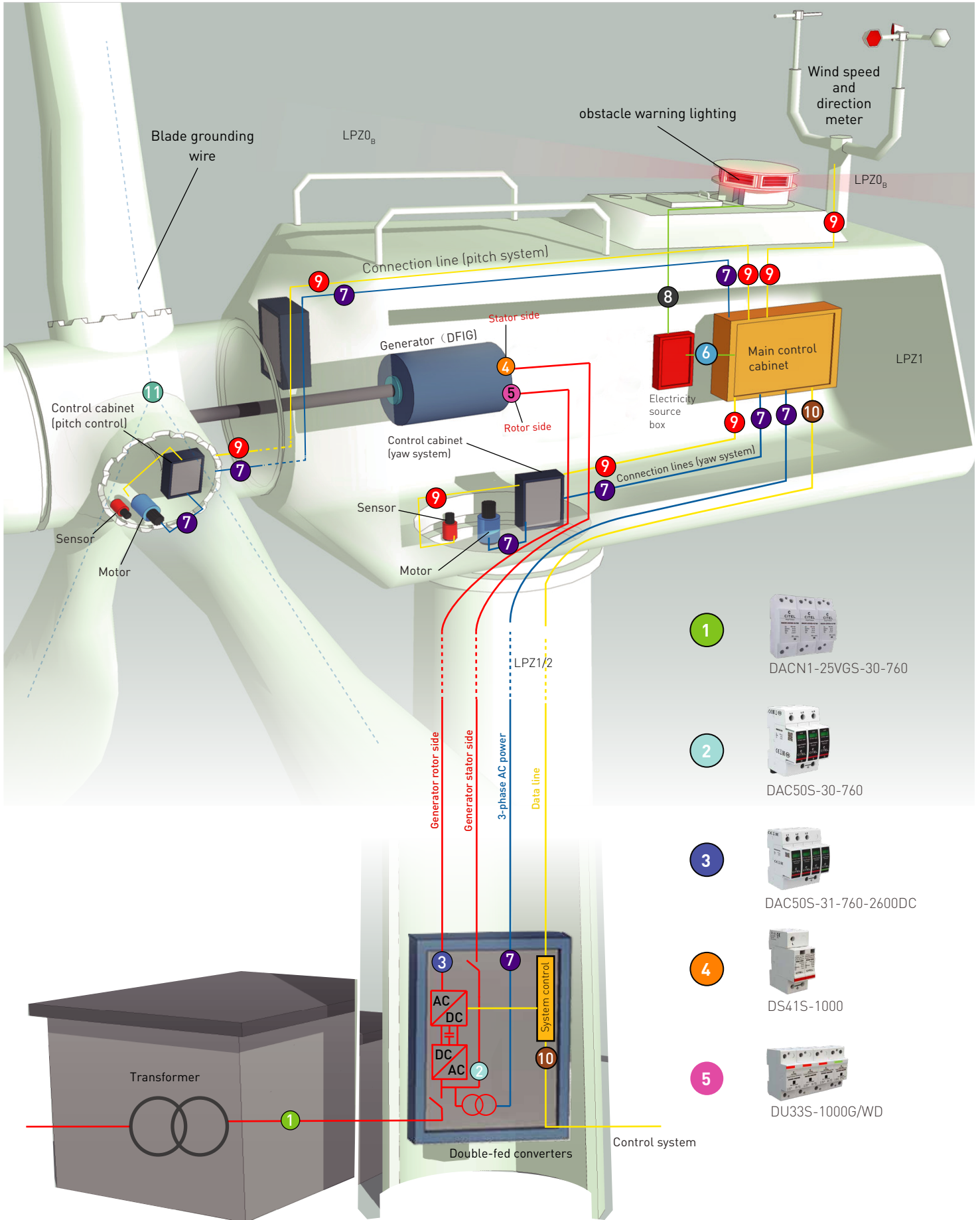

# PERMANENT MAGNET SYNCHRONOUS GENERATOR (PMSG) SURGE PROTECTION SOLUTIONS

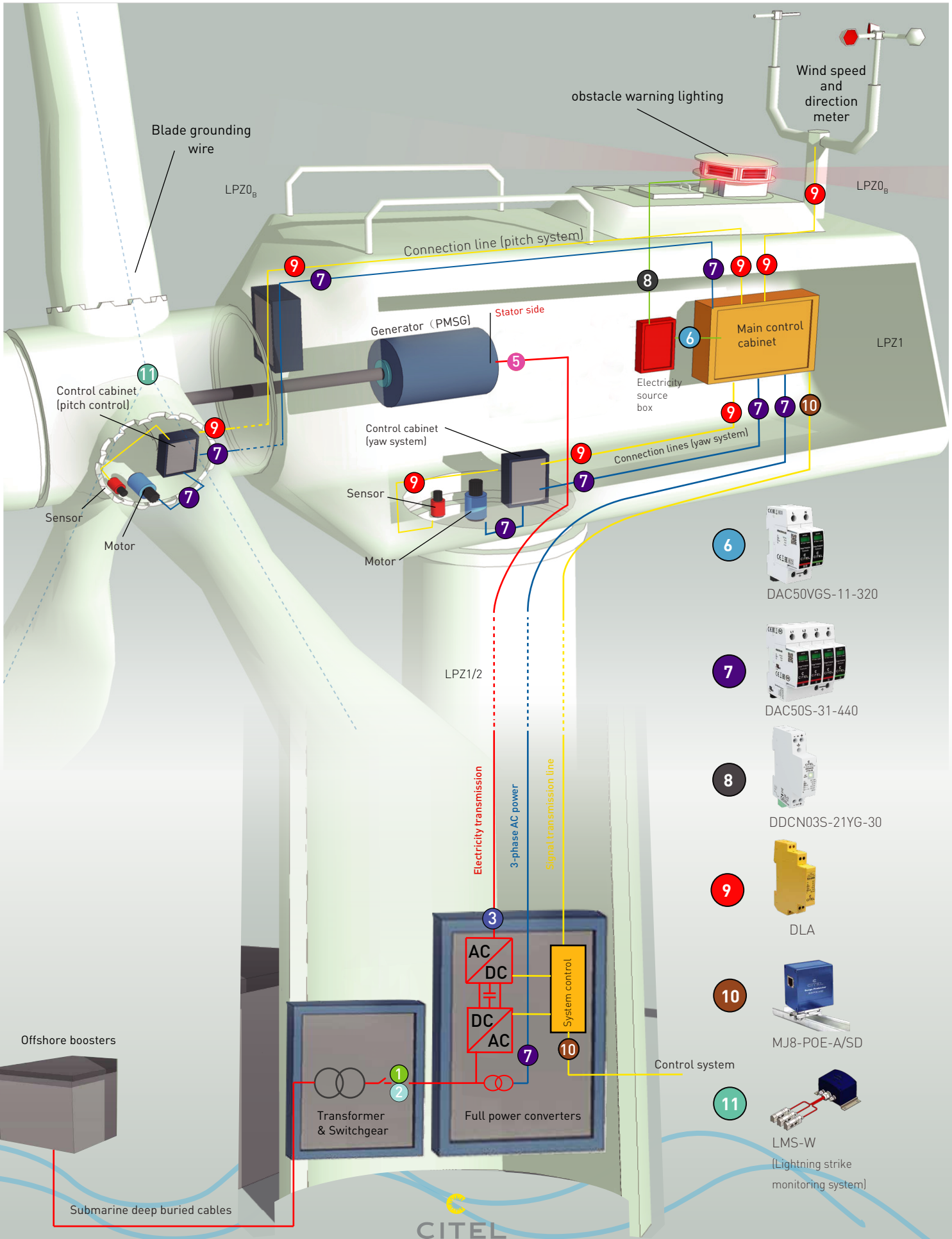



# WIND TURBINE SURGE PROTECTION SOLUTIONS

## Examples of electrical systems for onshore wind DFIG models

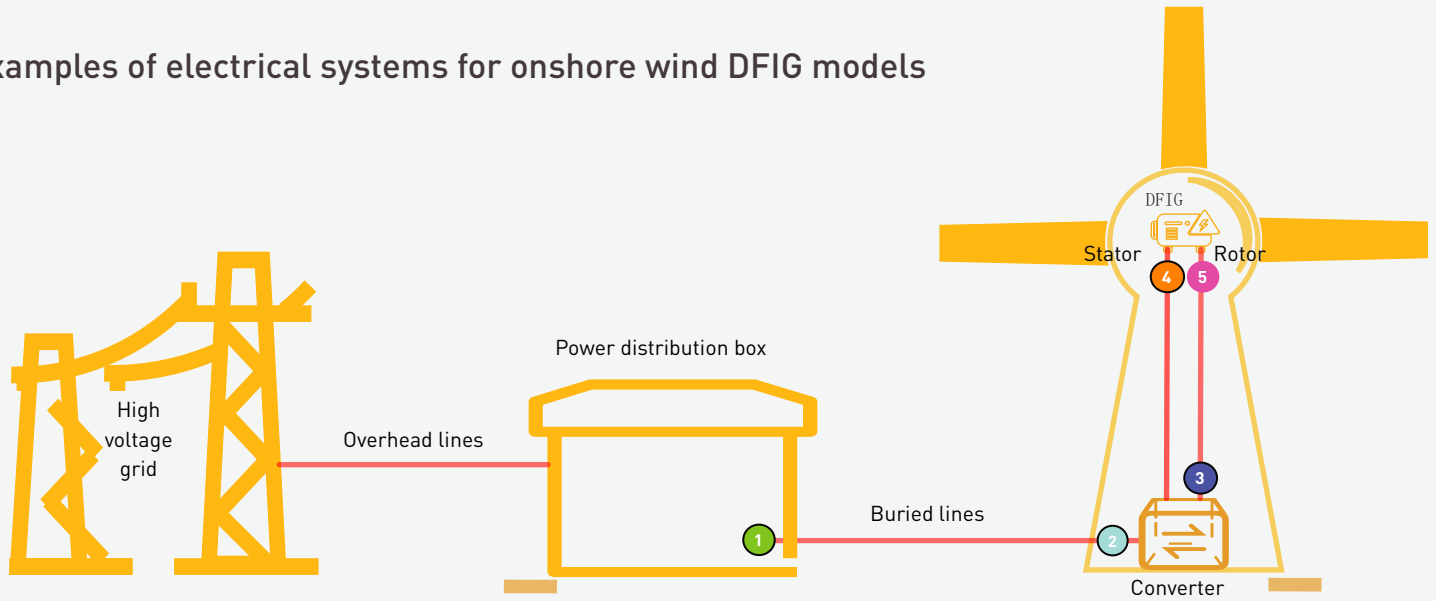

### 1 Protection of the low voltage side of the substation

#### DACN1-25VGS-30-760

Type 1+2+3 SPD, VG technology, strong discharge capability, high TOV tolerance, long service life, very low residual voltage, monobloc structure.



Uc	Iimp/I <sub>max</sub>	Up	Width	Certification
760 Vac	25 kA/ 70 kA	2.5 kV	36x3 mm	TUV/CE

### 2 Converter grid side protection

#### DAC50S-30-760

Type 2 SPD, strong discharge capability, high TOV withstanding capability, MOV protection technology, pluggable module, vibration resistant latching design.



Uc	Iimp/I <sub>max</sub>	Up	Width	Certification
760 Vac	20 kA/ 50 kA	3.5 kV	54 mm	OVE/CE

#### DACN1-35VGS-30-440

Type 1+2+3 SPD, VG technology, very strong discharge capacity, long service life, very low residual voltage, monobloc structure.



Uc	Iimp/I <sub>max</sub>	Up	Width	Certification
440 Vac	35 kA/ 70 kA	1.8 kV	36x3 mm	CE

#### DS43S-690

Type 2 SPD, high TOV withstanding capability, MOV protection technology, pluggable modules.



Uc	Iimp/I <sub>max</sub>	Up	Width	Certification
760 Vac	20 kA/ 40 kA	3.5 kV	54 mm	UL/TUV /CE

#### DS253VG-1000

Type 1+2+3 SPD, VG technology, strong discharge capability, high TOV tolerance, long service life, low residual voltage, monobloc structure.



Uc	Iimp/I <sub>max</sub>	Up	Width	Certification
1000 Vac	25 kA/ 70 kA	4.0 kV	90x3 mm	CE

CITEL has different surge protection devices for different wind turbines

## Example of electrical system for offshore wind PMSG models

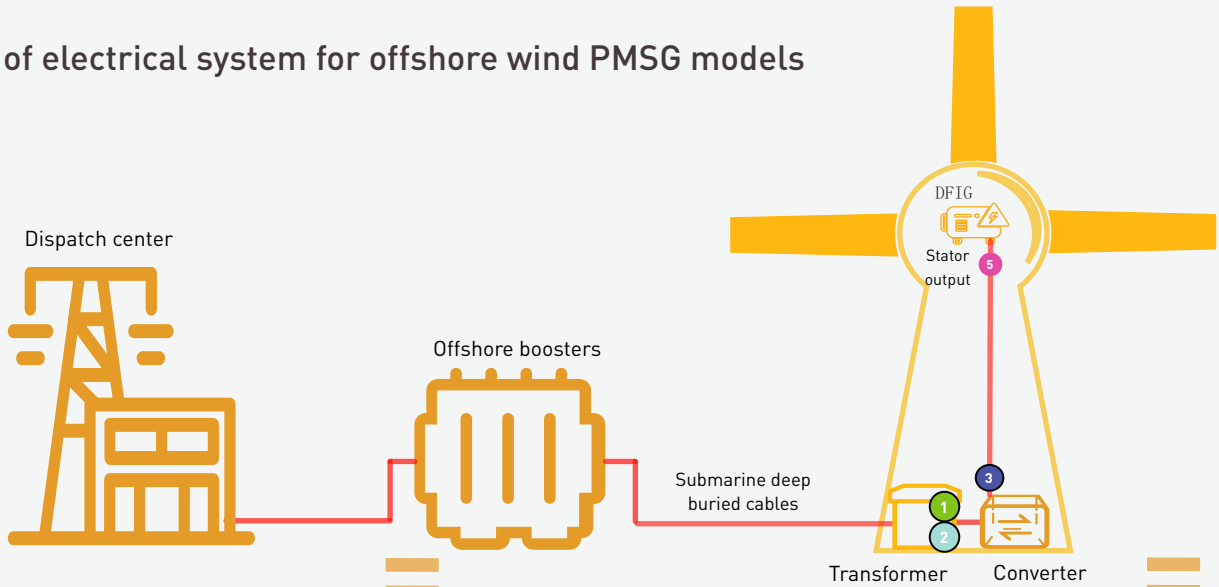

### 3 Converter machine side protection

#### DAC50S-31-760-2600DC

Type 2 SPD, withstand high harmonic interference from wind turbines, MOV+GSG protection, strong discharge capability, high TOV tolerance, pluggable modules, vibration resistant latching design.



Uc	In/Imax	Up	Width	Certification
800 Vac	20 kA/ 50 kA	4.0 kV	72 mm	CE

#### DS41(S)-1000/WD

Type 2 SPD, high TOV withstanding capability, MOV protection technology, pluggable module, with certain harmonic interference withstanding capability.

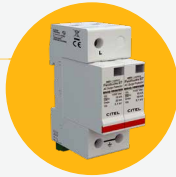

Uc	In/Imax	Up	Width	Certification
1100 Vac	15 kA/ 30 kA	5.1 kV	36x3 mm	CE

### 4 Generator protection (DFIG)

#### DS41S-1000

Type 2 SPD, high TOV withstanding capability, MOV protection technology, pluggable module, split combination structure to increase insulation capability

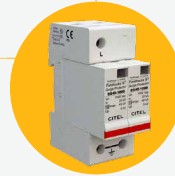

Uc	In/Imax	Up	Width	Certification
1100 Vac	20 kA/ 40 kA	5.0 kV	36x3 mm	CE

#### DU33S-1000/WD

Type 2 SPD, high TOV withstanding capability, low residual voltage, MOV protection technology, single-mode integrated structure to meet vibration and insulation requirements.



Uc	In/Imax	Up	Width	Certification
1000 Vac	15 kA/ 30 kA	4.2 kV	36x3 mm	TUV/CE

### 5 Generator protection (DFIG & PMSG)

#### DU33S-1000G/WD

Type 2 SPD, withstand high harmonic interference from wind turbines, MOV+GSG protection, high TOV tolerance, single-mode integrated structure to meet vibration and insulation requirements.



Uc	In/Imax	Up	Width	Certification
1000 Vac	15 kA/ 30 kA	8.0 kV	36x4 mm	TUV/CE

Talk to a CITELENGINEER  
for the best  
SPD selection options



# WIND TURBINE SURGE PROTECTION SOLUTIONS

## Example of wind turbine main control & pitch system

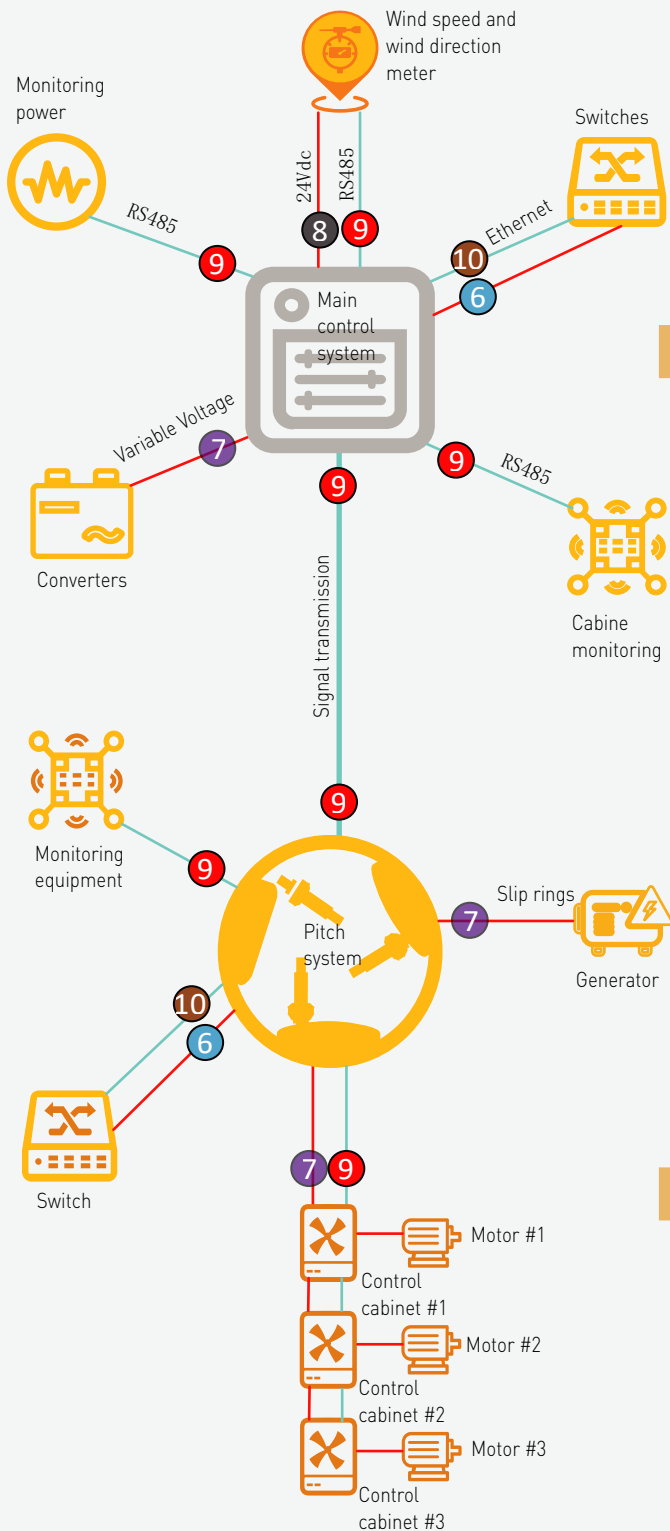

### 6 Single-phase AC power 230 Vac

#### DAC50VGS-11-320

Type 2+3 SPD, strong discharge capability, long life of VG technology, very low residual voltage, high TOV tolerance, pluggable modules, vibration resistant latch design



Uc	In/Imax	Up	Width	Certification
320 Vac	20 kA/ 50 kA	1.5 kV	36 mm	CB/ KEMA/CE

#### DS42S-400/G

Type 2 SPD, high TOV withstanding grid fault overvoltage capability, MOV protection technology, pluggable modules.



Uc	In/Imax	Up	Width	Certification
440Vac	20 kA/ 40 kA	1.8 kV	36 mm	UL/ TUV/CE

### 7 3-phase power supply 230/400 Vac

#### DAC50VGS-31-320

Type 2+3 SPD, strong discharge capability, long life of VG technology, very low residual voltage, high TOV tolerance, pluggable modules, vibration resistant latch design



Uc	In/Imax	Up	Width	Certification
320 Vac	20 kA/ 50 kA	1.5 kV	36 mm	CB/ KEMA/CE

#### DS44S-400/G

Type 2 SPD, high TOV withstanding grid fault overvoltage capability, MOV protection technology, pluggable modules.



Uc	In/Imax	Up	Width	Certification
440Vac	20 kA/ 40 kA	1.8 kV	36 mm	GB/UL/ TUV/EAC

## 8 DC power supply 24 Vdc

### DDCN03S-21YG-30

Type 2+3 SPD, series/parallel installation, common mode & differential mode fine protection, MOV+GDT circuit structure, high load current, compact design, monobloc structure.



Uc	Uoc/Imax	Up	Width	Certification
30Vdc	3.0 kV/ 3 kA	0.2 kV(DM) 0.8 kV(CM)	18 mm	CE

## 9 Telecommunication signal lines

### DLA/DLA2 series

1/2 pair line protection, D1&C2&C3 type surge protection, pluggable module, very low residual voltage, common mode & differential mode protection, suitable for RS485, CAN and other communications.



Model	Uc	Cut-off frequency fG@1dB	Discharge current D1/C2	Up@C3	Certification
DLA-06DBC DLA2-06DBC	8 Vdc	20 MHz	5 kA /5kA	25 V	UL/CE
DLA-24D3 DLA2-24D3	28 Vdc	3 MHz	5 kA /5kA	40 V	UL/CE

### DLU/DLU2 series

1/2 pair line protection, D1&C2&C3 type surge protection, integrated structure, very low residual voltage, common mode & differential mode protection, suitable for RS485, CAN and other communications.



Model	Uc	Cut-off frequency fG@1dB	Discharge current D1/C2	Up@C3	Certification
DLU-06DBC DLU2-06DBC	8 Vdc	20 MHz	5 kA /5kA	25 V	UL/CE
DLU-24D3 DLU2-24D3	28 Vdc	3 MHz	5 kA /5kA	40 V	UL/CE

### DLC series

1 pair of line protection, D1&C2&C3 type surge protection, extremely slim design, very low residual voltage, common mode & differential mode protection, suitable for RS485, CAN and other communications

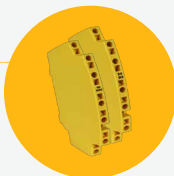

Model	Uc	Cut-off frequency fG@1dB	Discharge current D1/C2	Up@C3	Certification
DLC-06DBC	8 Vdc	20 MHz	2.5 kA /5kA	25 V	UL/CE
DLC-24D3	28 Vdc	3 MHz	2.5 kA /5kA	40 V	UL/CE

## 10 Data communication network

### MJ8-C6A

RJ45 port for CAT6A, Category D1&C2&C3 surge protection, metal shielded enclosure, common mode & differential mode protection, very low residual voltage.



Uc	Transmission Rate Rb	Discharge current D1/C2	Up@C3	Certification
8 Vdc	10 Gbps	0.5 kA /2 kA	20 V	CE

### MJ8-POE-C6A

RJ45 port, POE&POE+(:CAT6A, D1&C2&C3 type surge protection, metal shielded housing, common mode & differential mode protection.



Uc	Transmission Rate Rb	Discharge current D1/C2	Up@C3	Certification
8 Vdc/60Vdc RJ45	10 Gbps	0.5 kA /2.0 kA	70 V	CE

### MJ8-POE-A/SD

RJ45 port, fastened rail mount, POE&POE+(:CAT5E, metal shielded housing, common mode & differential mode protection.



Uc	Transmission Rate Rb	Discharge current D1/C2	Up@C3	Certification
8 Vdc/60Vdc RJ45	1 Gbps	0.5 kA /2 kA	70 V	CE

## 11 Lightning strike monitoring system

### LMS-W

Intelligent monitoring of lightning amplitude, lightning strike blade channel and time of occurrence and other parameters can be transmitted to the monitoring system through RS485 to achieve data transmission.

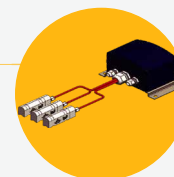

Lightning Current Amplitude	Communication method	Communication protocol	Storage capacity	Temperature range
10 kA~ 200 kA	RS485	MODBUS RTU	3600 events	-40°C~70°C



# CITEL

## Head office

France  
Tel.: +33 1 41 23 50 23  
e-mail: [contact@citel.fr](mailto:contact@citel.fr)  
Website: [www.citel.fr](http://www.citel.fr)

## CITEL-China

Shanghai  
Tel.: +86 21 58 12 25 25  
e-mail: [info@citelsh.com](mailto:info@citelsh.com)  
Website: [www.citel.cn](http://www.citel.cn)

## Factory

France  
Reims  
Tel.: +33 3 26 85 74 00  
e-mail : [contact@citel.fr](mailto:contact@citel.fr)

## Russia

Moscou  
Tel.: +7 499 391 47 64  
e-mail: [info@citel.ru](mailto:info@citel.ru)  
Website: [www.citel.ru](http://www.citel.ru)

## Germany

Bochum  
Tel.: +49 2327 6057 0  
e-mail: [info@citel.de](mailto:info@citel.de)  
Website: [www.citel.de](http://www.citel.de)

## India

New Delhi  
Tel.: +91 11 4001 81 31  
e-mail: [indiacitel@gmail.com](mailto:indiacitel@gmail.com)  
Website: [www.citel.in](http://www.citel.in)

## USA

Miramar  
Tel.: (954) 430 6310  
e-mail: [info@citel.us](mailto:info@citel.us)  
Website: [www.citel.us](http://www.citel.us)

## Thailand

Bangkok  
Tel.: +66 (0) 2 104 9214  
Website: [www.citel.fr](http://www.citel.fr)

## U.A.E

Dubai  
e-mail: [contact@citel.fr](mailto:contact@citel.fr)  
Web : [www.citel.fr](http://www.citel.fr)

