

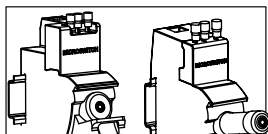

CITEL

N210101B

ASSEMBLY INSTRUCTIONS - NOTICE D'ASSEMBLAGE
NOTICIA DE INSTALACIÓN - MONTAGEANLEITUNGEN
ISTRUZIONI DI MONTAGGIO
INSTRUÇÕES DE MONTAGEM - MONTÁŽNÍ NÁVOD
РУКОВОДСТВО ПО СБОРКЕ - 组装说明



Microswitch for Remote signal
SFD1-13-20S & SFD1-13-40S
SFD1-25-20S & SFD1-25-40S

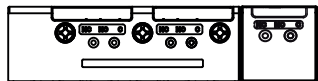

Microswitch 3 P + Microswitch 1 P



2 x Microswitch 1 P

Assembly

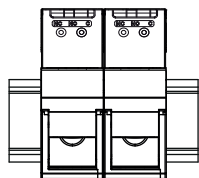

SFD1-13-20S

2 x Microswitch 1 P

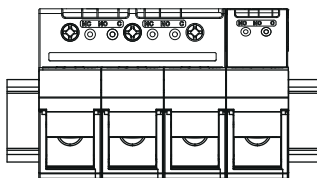

SFD1-13-40S

Microswitch 3 P + Microswitch 1 P

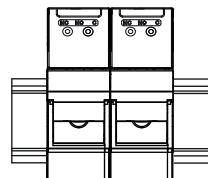

SFD1-25-20S

2 x Microswitch 1 P

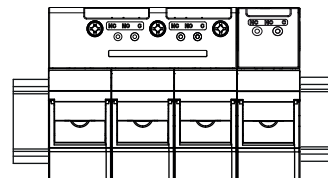

SFD1-25-40S

Microswitch 3 P + Microswitch 1 P

1 Connect the Fuse holder by the main terminals

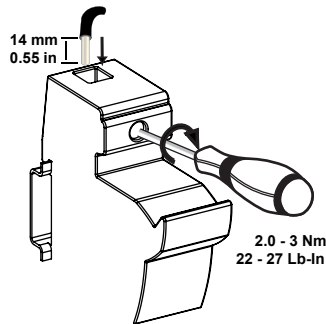

2.0 - 3 Nm
22 - 27 Lb-In

2 Put on the microswitch on the guides

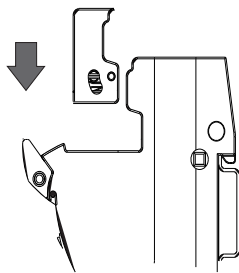

3 Push in horizontal movement to the final position.

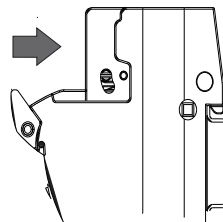

4 Then connect the microswitch following the instructions in the Installation Sheet (N201102 & N201103)

Identification - Labels

Labels are provided by a batch of 4, for each SFD fuse holder.

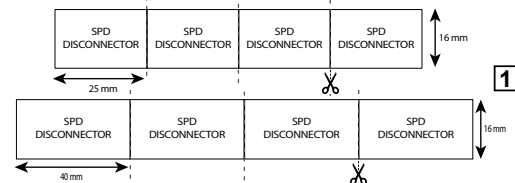

1 Cut labels at the right dimensions, ✂

3 Put on the label, and close.

2 Open the label-holder part when the fuseholder is totally closed or totally open,

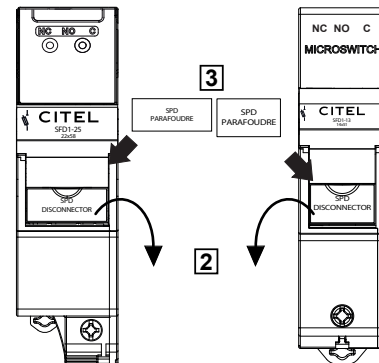



2, rue Troyon 92316
Sèvres CEDEX France



SAFETY INSTRUCTIONS
CONSIGNES DE SECURITE
SICHERHEITSHINWEISE
ADVERTENCIA DE SEGURIDAD
AVVERTENZE IMPORTANTI
BEZPEČNOSTNÍ POKYNY
安全须知
AVISOS IMPORTANTES
МЕРЫ БЕЗОПАСНОСТИ
WSKAZÓWKI BEZPIECZEŃSTWA

VARNOSTA NAVODILA
VEILIGHEIDSVOORSCHRIFTEN
BEZPEČNOSTNÉ POKYNY
SIKKERHEDSANVISNINGER
SÄKERHETSANVISNINGAR

www.citel.fr
www.citel.de
www.citel.us
www.citel.com.cn
www.citel.ru
www.citel.in

