



CITEL

Isolating spark gap (ISG)

BF PS 230/20



- › Isolating spark gap
- › Outdoor application
- › Max. discharge current: 100 kA
- › EN 62561-3 compliance

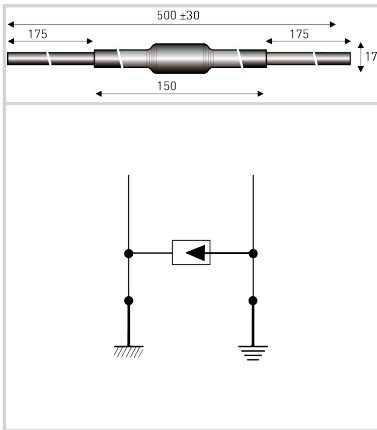

Electrical Characteristics

Rated DC withstand voltage	Uw DC	184 V
Rated AC withstand voltage	Uw AC	130 V
Max. discharge current <i>max. withstand @ 8/20 μs by pole</i>	Imax	100 kA
Impulse current by pole <i>max. withstand 10/350 μs by pole</i>	Iimp	50 kA
Classification following IEC 62561-3		N
Rated impulse sparkover voltage <i>1kV/μs</i>	Ur Iimp	900 V

Mechanical Characteristics

Technology		Gas discharge tube
Connection to Network		Wire
Operating temperature	Tu	-40/+85°C
Protection rating		IP67
Number of units per package		1 unit per packaging
Dimensions		See diagram
Weight		0.122 kg

Standards

Standards compliance		EN 62561-3
RohS compliance		Yes

Part number

90231657

