

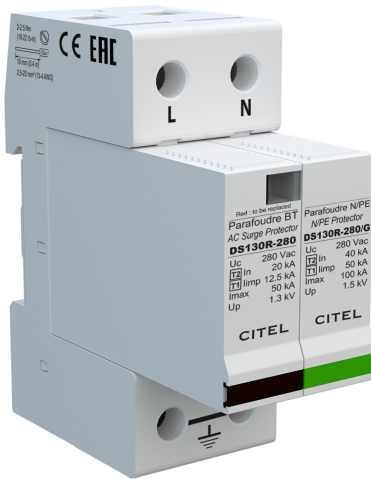

CITEL

Type 1+2 AC surge protector single-phase

DS132R-280/G



- › Discover our latest innovation : the [DAC1-13-11-320](#)
- › Type 1 + 2 AC multipolar surge protector
- › In : 20 kA
- › Iimp total : 25 kA
- › Pluggable module for each phase
- › Remote signaling (option)
- › EN 61643-11, IEC 61643-11 compliance

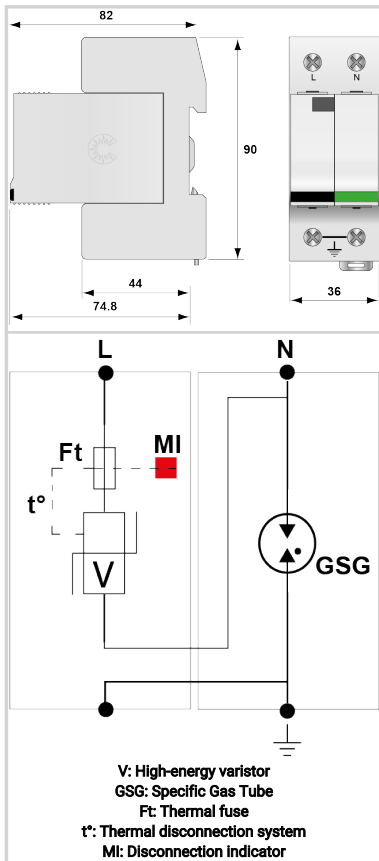

Electrical Characteristics

SPD type	IEC	1+2
Network		230/400 V
AC system		TT-TN
Nominal line voltage	Un	230 Vac
Max. AC operating voltage	Uc	280 Vac
Temporary Over Voltage (TOV) Characteristics - 5 sec. Without disconnection	UT	335 Vac withstand
Temporary Over Voltage (TOV) Characteristics - 120 mn Without disconnection or with safety disconnection	UT	440 Vac disconnection
Temporary Over Voltage N/PE (TOV HT) Without disconnection or with safety disconnection	UT	1200 V/300A/200 ms withstand
Follow current	If	None
Nominal discharge current 15 x 8/20 μs impulses	In	20 kA
Max. discharge current max. withstand @ 8/20 μs by pole	I _{max}	50 kA
Impulse current by pole max. withstand 10/350 μs by pole	I _{imp}	12.5 kA
Total lightning current max. total withstand @ 10/350 μs	I _{total}	25 kA
Withstand on overvoltages IEEE C62.41.1		20 kV
Specific energy by pole max. withstand 10/350 μs	W/R	40 kJ/ohm
Connection mode(s)		L/N and N/PE
Protection mode(s)		Common/Differential mode
Protection level L/N @ In (8/20 μs)	Up L/N	1.3 kV
Protection level N/PE @ In (8/20 μs)	Up N/PE	1.5 kV
Admissible short-circuit current	I _{sc}	25 000 A

Mechanical Characteristics

Technology		MOV
SPD configuration		Single phase
Connection to Network		By screw terminals: 2.5-25mm ² / by bus
Format		Plug-in modular box
Mounting		Symmetrical rail 35 mm (EN 60715)
Housing material		Thermoplastic UL94 V-0
Operating temperature	Tu	-40/+85°C
Protection rating		IP20
Failsafe mode		Disconnection from AC network
Disconnection indicator		1 mechanical indicator by pole
Spare module(s)		DSM130R-280 + DSM130R-280/G
Remote signaling of disconnection		option DS132RS-280/G : output on changeover contact
Dimensions		See diagram

Disconnectors

Thermal disconnector		Internal
Installation ground fault breaker		Type 'S' or delayed
Back-up protection device		Fuses Type gG - 125 A

Standards

Standards compliance		IEC 61643-11 / EN 61643-11 / UL1449 ed.5
Certification		

Part number

571122

